





Entry Max

Codice	Modello	Dimensioni LxPxH cm			
P07EN10083	MAX 4	↔ 99	↗ 92	↕ 38	
	Controllo	Altezza camera cm	Superficie di cottura cm		
	Manual	15	70x70		
	Capacità pizze	Temperatura Max	Peso Kg		
	4 x Ø 30/34	 450 °C	 74		
	Potenza Totale KW	Voltaggio V	Fasi Ph	Frequenza Hz	
	5,60	400	3N+T	50/60	



Entry Max

Codice

P07EN10083

Modello

MAX 4

Caratteristiche Generali

Disponibile nella versione completamente con pietra refrattaria.

Tempi di riscaldamento, cottura e consumo totale di energia ridotti.

Raggiunge fino a 450° per tutte le esigenze di cottura.



Entry Max

Codice

P07EN10083

Modello

MAX 4

Options

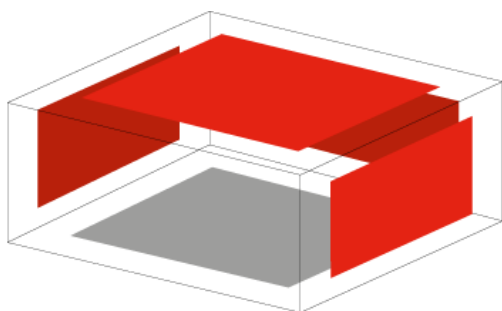

CAMERA REFRAATTARIA ENTRY MAX

CAMERA INTERNA RICOPERTA DA PIETRA REFRAATTARIA

Dimensioni superficie di cottura (L x p x h cm)

Codice



67x68,5x15

S950065001



Entry Max

Codice
P07EN10083

Modello
MAX 4

Accessori



SUPPORTO ENTRY MAX

SUPPORTO IN ACCIAIO INOX

	Codice	Modello	Dimensioni con piedi cm	Dimensioni con ruote cm	Dimensioni interne cm	Peso
	P11FN55001	S4	99x82x105/108	99x82x106	82x65x73	30

Option

ruote

Set di 4 ruote rotanti 2 con freno + 2 senza freno

Codice

S66RU65003



Entry Max

Codice
P07EN10083

Modello
MAX 4

Accessori



CAPPA ENTRY MAX

CAPPA IN ACCIAIO INOX DIAMETRO USCITA FUMI 125-200mm

	Codice	Modello	Voltage V	Fasi Ph	Frequenza Hz	Luce	Dimensioni cm	Peso
	P13EN10010	K4-K8	230	1N + T	50	S	99x88x15	10

Option

MOTORE CAPPA

MOTORE ELETTRICO DI ASPIRAZIONE (ASSORBIMENTO 50 w) Con regolazione velocità - power 313 m³/h

	Codice	Alimentazione V	Fasi Ph	Frequenza Hz	Peso netto Kg
	S66MT55001	230	1N + T	50	3



Entry Max

Codice

P07EN10083

Modello



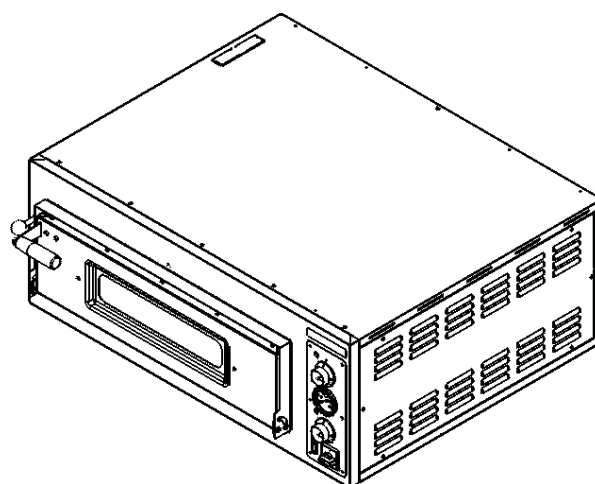
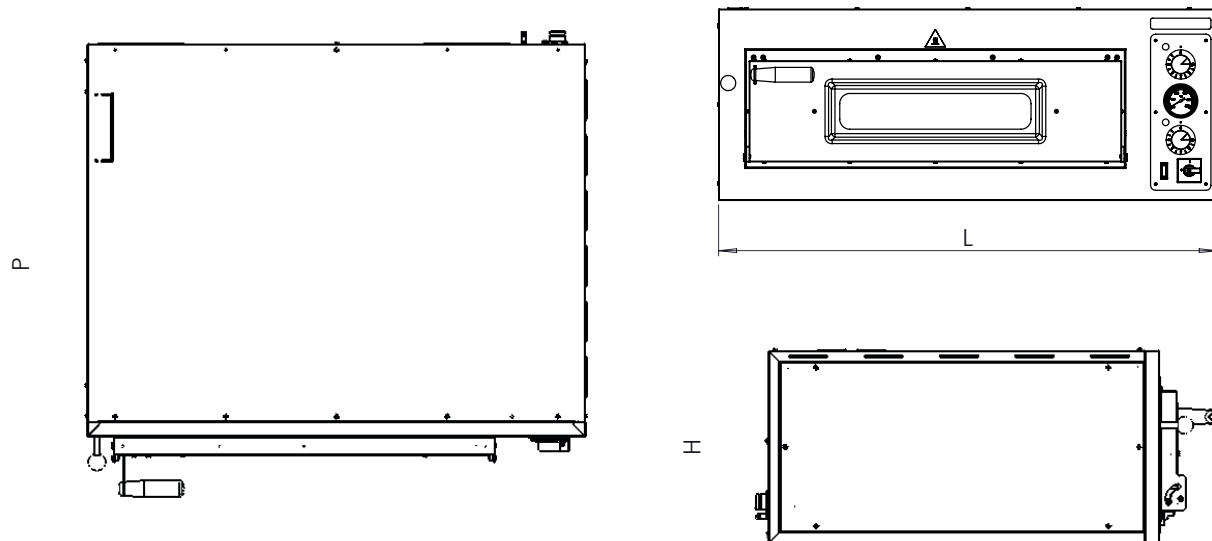

MAX 4



MOD	COD	DIMENSIONS (cm)		
		L	P	H
4	P07EN10083	99	92	38
6	P07EN10084	99	127	38
6L	P07EN10085	134	92	38
9	P07EN10086	134	127	38
8	P07EN10087	99	92	68
12	P07EN10088	99	127	68
12L	P07EN10089	134	92	68
18	P07EN10090	134	127	68



Entry Max

Codice	Modello	Dimensioni LxPxH cm			
P07EN10084	MAX 6	↔ 99	↗ 127	↕ 38	
	Controllo	Altezza camera cm	Superficie di cottura cm		
	Manual	15	70x105		
	Capacità pizze	Temperatura Max	Peso Kg		
	6 x Ø 30/34	 450 °C	 97		
	Potenza Totale KW	Voltaggio V	Fasi Ph	Frequenza Hz	
	7,30	400	3N+T	50/60	



Entry Max

Codice

P07EN10084

Modello

MAX 6

Caratteristiche Generali

Disponibile nella versione completamente con pietra refrattaria.

Tempi di riscaldamento, cottura e consumo totale di energia ridotti.

Raggiunge fino a 450° per tutte le esigenze di cottura.



Entry Max

Codice

P07EN10084

Modello

MAX 6

Options

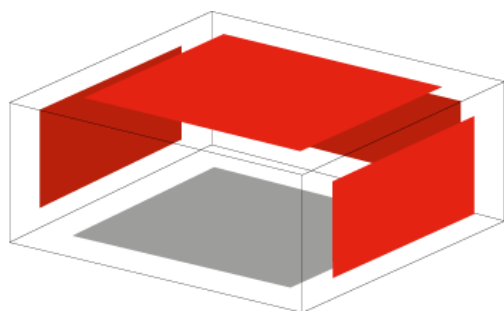

CAMERA REFRAATTARIA ENTRY MAX

CAMERA INTERNA RICOPERTA DA PIETRA REFRAATTARIA

Dimensioni superficie di cottura (L x p x h cm)

Codice



67x103,5x15

S950065002



Entry Max

Codice
P07EN10084

Modello
MAX 6

Accessori



SUPPORTO ENTRY MAX

SUPPORTO IN ACCIAIO INOX

	Codice	Modello	Dimensioni con piedi cm	Dimensioni con ruote cm	Dimensioni interne cm	Peso
	P11FN55002	S6	99x112x105/108	S6 99x112x106	82x95x73	31

Option

ruote

Set di 4 ruote rotanti 2 con freno + 2 senza freno

Codice

S66RU65003



Entry Max

Codice
P07EN10084

Modello
MAX 6

Accessori



CAPPA ENTRY MAX

CAPPA IN ACCIAIO INOX DIAMETRO USCITA FUMI 125-200mm

	Codice	Modello	Voltage V	Fasi Ph	Frequenza Hz	Luce	Dimensioni cm	Peso
	P13EN10011	K6 - K12	230	1N + T	50	S	99x123x15	13

Option

MOTORE CAPPA

MOTORE ELETTRICO DI ASPIRAZIONE (ASSORBIMENTO 50 w) Con regolazione velocità - power 313 m³/h

	Codice	Alimentazione V	Fasi Ph	Frequenza Hz	Peso netto Kg
	S66MT55001	230	1N + T	50	3



Entry Max

Codice

P07EN10084

Modello



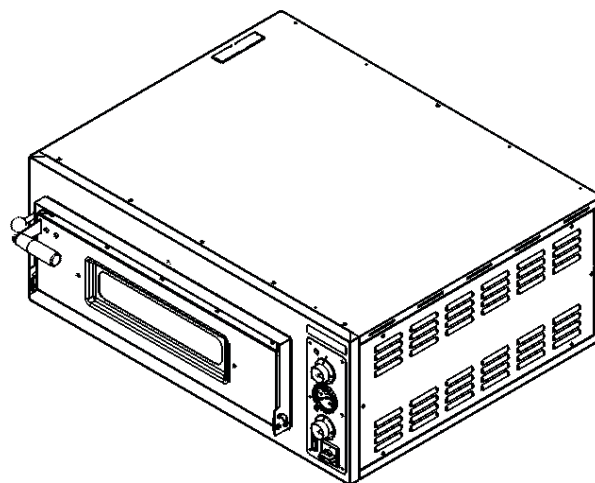
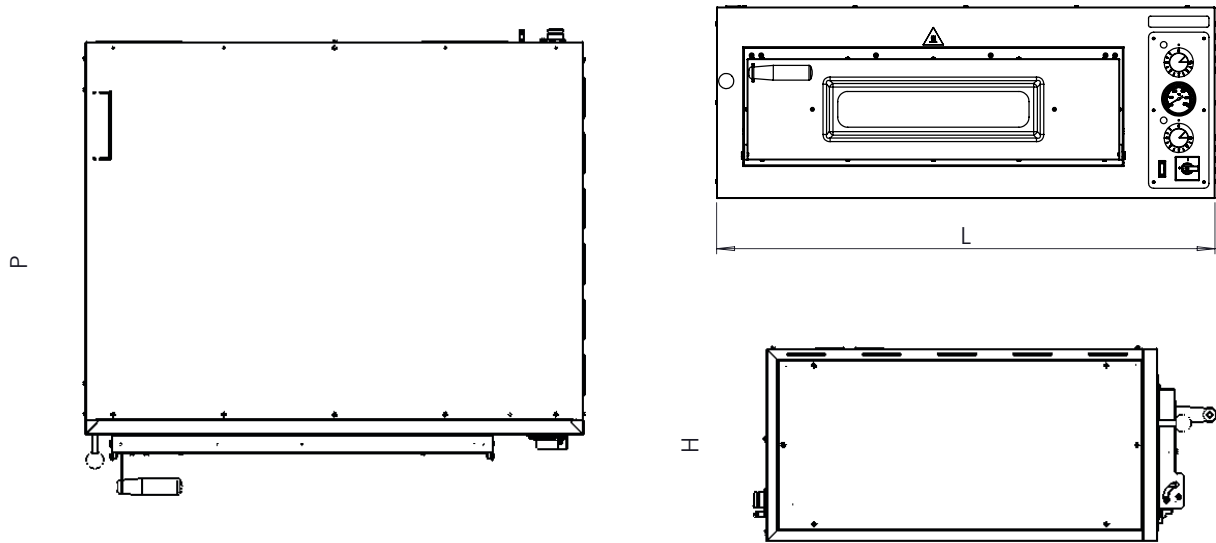

MAX 6



MOD	COD	DIMENSIONS (cm)		
		L	P	H
4	P07EN10083	99	92	38
6	P07EN10084	99	127	38
6L	P07EN10085	134	92	38
9	P07EN10086	134	127	38
8	P07EN10087	99	92	68
12	P07EN10088	99	127	68
12L	P07EN10089	134	92	68
18	P07EN10090	134	127	68



Entry Max

Codice	Modello	Dimensioni LxPxH cm			
P07EN10085	MAX 6L	↔ 134	↗ 92	↕ 38	
	Controllo	Altezza camera cm	Superficie di cottura cm		
	Manual	15	105x70		
	Capacità pizze	Temperatura Max	Peso Kg		
	6 x Ø 30/34	 450 °C	 97		
	Potenza Totale KW	Voltaggio V	Fasi Ph	Frequenza Hz	
	9,90	400	3N+T	50/60	



Entry Max

Codice

P07EN10085

Modello

MAX 6L

Caratteristiche Generali

Disponibile nella versione completamente con pietra refrattaria.

Tempi di riscaldamento, cottura e consumo totale di energia ridotti.

Raggiunge fino a 450° per tutte le esigenze di cottura.



Entry Max

Codice

P07EN10085

Modello

MAX 6L

Options

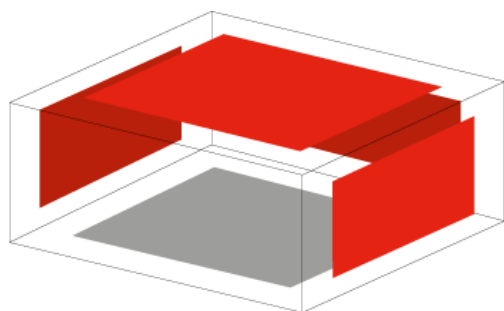

CAMERA REFRATTARIA ENTRY MAX

CAMERA INTERNA RICOPERTA DA PIETRA REFRATTARIA

Dimensioni superficie di cottura (L x p x h cm)

Codice



102x68,5x15

S950065003



Entry Max

Codice
P07EN10085

Modello
MAX 6L

Accessori



SUPPORTO ENTRY MAX

SUPPORTO IN ACCIAIO INOX

	Codice	Modello	Dimensioni con piedi cm	Dimensioni con ruote cm	Dimensioni interne cm	Peso
	P11FN55003	S6L	132x82x105/108	S6L 132x82x106	115x65x73	31

Option

ruote

Set di 4 ruote rotanti 2 con freno + 2 senza freno

Codice

S66RU65003



Entry Max

Codice
P07EN10085

Modello
MAX 6L

Accessori



CAPPA ENTRY MAX

CAPPA IN ACCIAIO INOX DIAMETRO USCITA FUMI 125-200mm

	Codice	Modello	Voltage V	Fasi Ph	Frequenza Hz	Luce	Dimensioni cm	Peso
	P13EN10012	K6L - K12L	230	1N + T	50	S	134x88x15	13

Option

MOTORE CAPPA

MOTORE ELETTRICO DI ASPIRAZIONE (ASSORBIMENTO 50 w) Con regolazione velocità - power 313 m³/h

	Codice	Alimentazione V	Fasi Ph	Frequenza Hz	Peso netto Kg
	S66MT55001	230	1N + T	50	3



Entry Max

Codice

P07EN10085

Modello



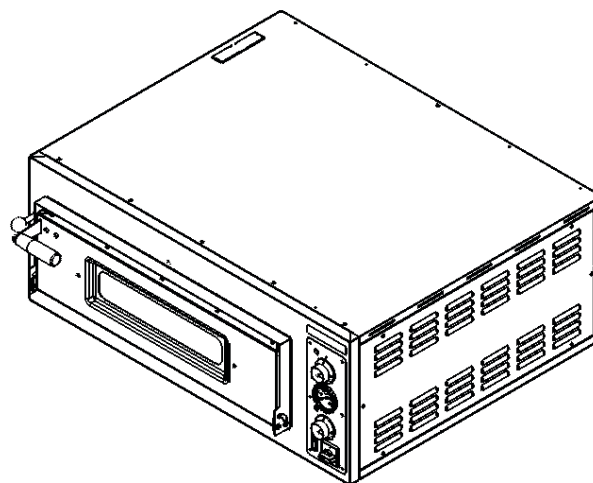
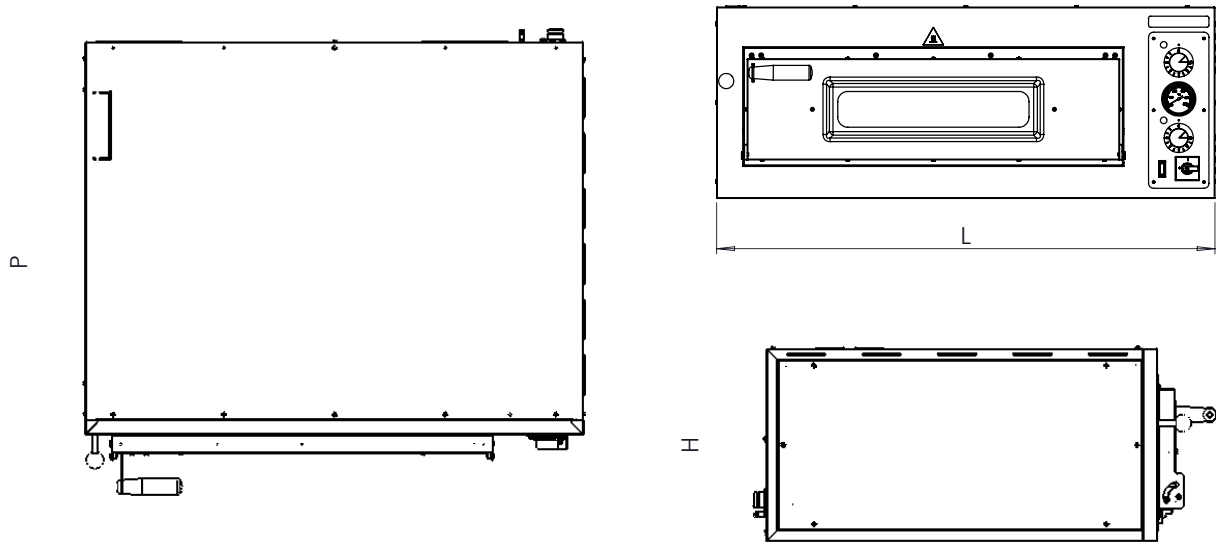

MAX 6L



MOD	COD	DIMENSIONS (cm)		
		L	P	H
4	P07EN10083	99	92	38
6	P07EN10084	99	127	38
6L	P07EN10085	134	92	38
9	P07EN10086	134	127	38
8	P07EN10087	99	92	68
12	P07EN10088	99	127	68
12L	P07EN10089	134	92	68
18	P07EN10090	134	127	68



Entry Max

Codice	Modello	Dimensioni LxPxH cm		
P07EN10086	MAX 9	↔ 134	↗ 127	↕ 38
	Controllo	Altezza camera cm	Superficie di cottura cm	
	Manual	15	105x105	
	Capacità pizze	Temperatura Max	Peso Kg	
	9 x Ø 30/34	 450 °C	 130	
	Potenza Totale KW	Voltaggio V	Fasi Ph	Frequenza Hz
	12,90	400	3N+T	50/60



Entry Max

Codice

P07EN10086

Modello

MAX 9

Caratteristiche Generali

Disponibile nella versione completamente con pietra refrattaria.

Tempi di riscaldamento, cottura e consumo totale di energia ridotti.

Raggiunge fino a 450° per tutte le esigenze di cottura.



Entry Max

Codice

P07EN10086

Modello

MAX 9

Options

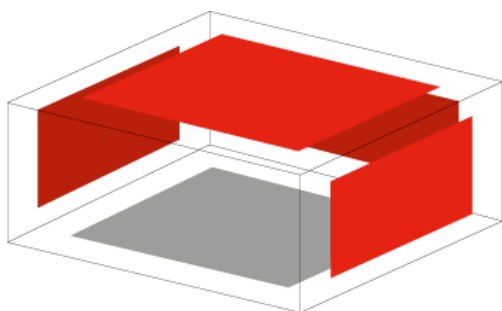

CAMERA REFRAATTARIA ENTRY MAX

CAMERA INTERNA RICOPERTA DA PIETRA REFRAATTARIA

Dimensioni superficie di cottura (L x p x h cm)

Codice



102x103,5x15

S950065004



Entry Max

Codice
P07EN10086

Modello
MAX 9

Accessori



SUPPORTO ENTRY MAX

SUPPORTO IN ACCIAIO INOX

	Codice	Modello	Dimensioni con piedi cm	Dimensioni con ruote cm	Dimensioni interne cm	Peso
	P11FN55004	S9	132x112x105/108	S9 132x112x106	115x95x73	33

Option

ruote

Set di 4 ruote rotanti 2 con freno + 2 senza freno

Codice

S66RU65003



Entry Max

Codice
P07EN10086

Modello
MAX 9

Accessori



CAPPA ENTRY MAX

CAPPA IN ACCIAIO INOX DIAMETRO USCITA FUMI 125-200mm

	Codice	Modello	Voltage V	Fasi Ph	Frequenza Hz	Luce	Dimensioni cm	Peso
	P13EN10013	K9 - K18	230	1N + T	50	S	134x123x15	16

Option

MOTORE CAPPA

MOTORE ELETTRICO DI ASPIRAZIONE (ASSORBIMENTO 50 w) Con regolazione velocità - power 313 m3/h

	Codice	Alimentazione V	Fasi Ph	Frequenza Hz	Peso netto Kg
	S66MT55001	230	1N + T	50	3



Entry Max

Codice

P07EN10086

Modello



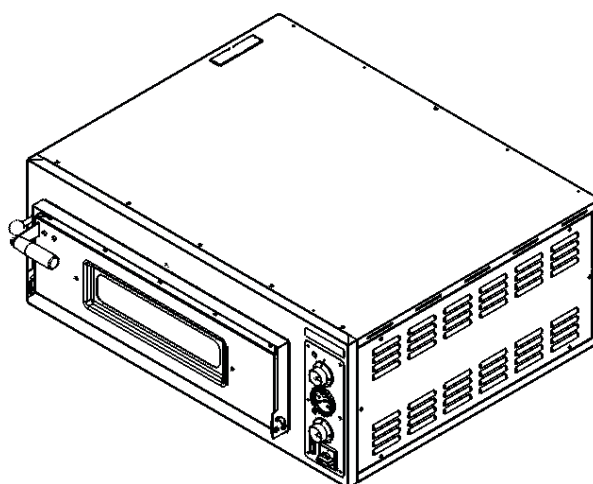
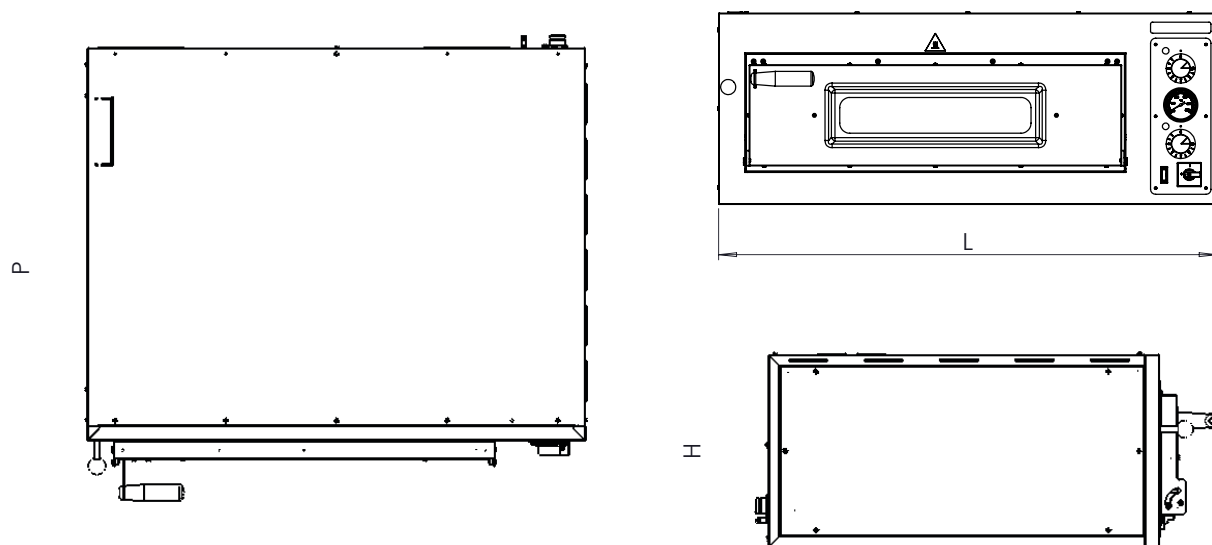

MAX 9



MOD	COD	DIMENSIONS (cm)		
		L	P	H
4	P07EN10083	99	92	38
6	P07EN10084	99	127	38
6L	P07EN10085	134	92	38
9	P07EN10086	134	127	38
8	P07EN10087	99	92	68
12	P07EN10088	99	127	68
12L	P07EN10089	134	92	68
18	P07EN10090	134	127	68



Entry Max

Codice	Modello	Dimensioni LxPxH cm			
P07EN10087	MAX 8	↔ 99	↗ 92	↕ 68	
	Controllo	Altezza camera cm	Superficie di cottura cm		
	Manual	15	70x70		
	Capacità pizze	Temperatura Max	Peso Kg		
	4 x Ø 30/34 (x2)	 450 °C	 149		
	Potenza Totale KW	Voltaggio V	Fasi Ph	Frequenza Hz	
	11,20	400	3N+T	50/60	



Entry Max

Codice

P07EN10087

Modello

MAX 8

Caratteristiche Generali

Disponibile nella versione completamente con pietra refrattaria.

Tempi di riscaldamento, cottura e consumo totale di energia ridotti.

Raggiunge fino a 450° per tutte le esigenze di cottura.



Entry Max

Codice

P07EN10087

Modello

MAX 8

Options

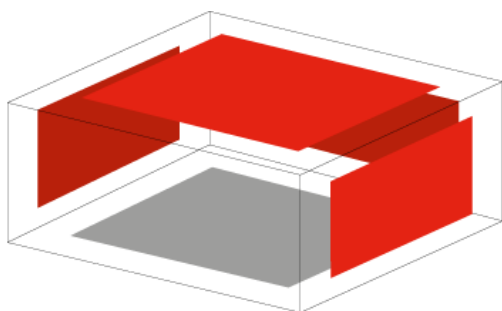

CAMERA REFRAATTARIA ENTRY MAX

CAMERA INTERNA RICOPERTA DA PIETRA REFRAATTARIA

Dimensioni superficie di cottura (L x p x h cm)

Codice



67x68,5x15

S950065009



Entry Max

Codice
P07EN10087

Modello
MAX 8

Accessori



SUPPORTO ENTRY MAX

SUPPORTO IN ACCIAIO INOX

	Codice	Modello	Dimensioni con piedi cm	Dimensioni con ruote cm	Dimensioni interne cm	Peso
	P11FN55005	S8	99x82x85/88	S8 99x82x86	82x65x53	28

Option

ruote

Set di 4 ruote rotanti 2 con freno + 2 senza freno

Codice

S66RU65003



Entry Max

Codice
P07EN10087

Modello
MAX 8

Accessori



CAPPA ENTRY MAX

CAPPA IN ACCIAIO INOX DIAMETRO USCITA FUMI 125-200mm

	Codice	Modello	Voltage V	Fasi Ph	Frequenza Hz	Luce	Dimensioni cm	Peso
	P13EN10010	K4-K8	230	1N + T	50	S	99x88x15	10

Option

MOTORE CAPPA

MOTORE ELETTRICO DI ASPIRAZIONE (ASSORBIMENTO 50 w) Con regolazione velocità - power 313 m³/h

	Codice	Alimentazione V	Fasi Ph	Frequenza Hz	Peso netto Kg
	S66MT55001	230	1N + T	50	3



Entry Max

Codice

P07EN10087

Modello



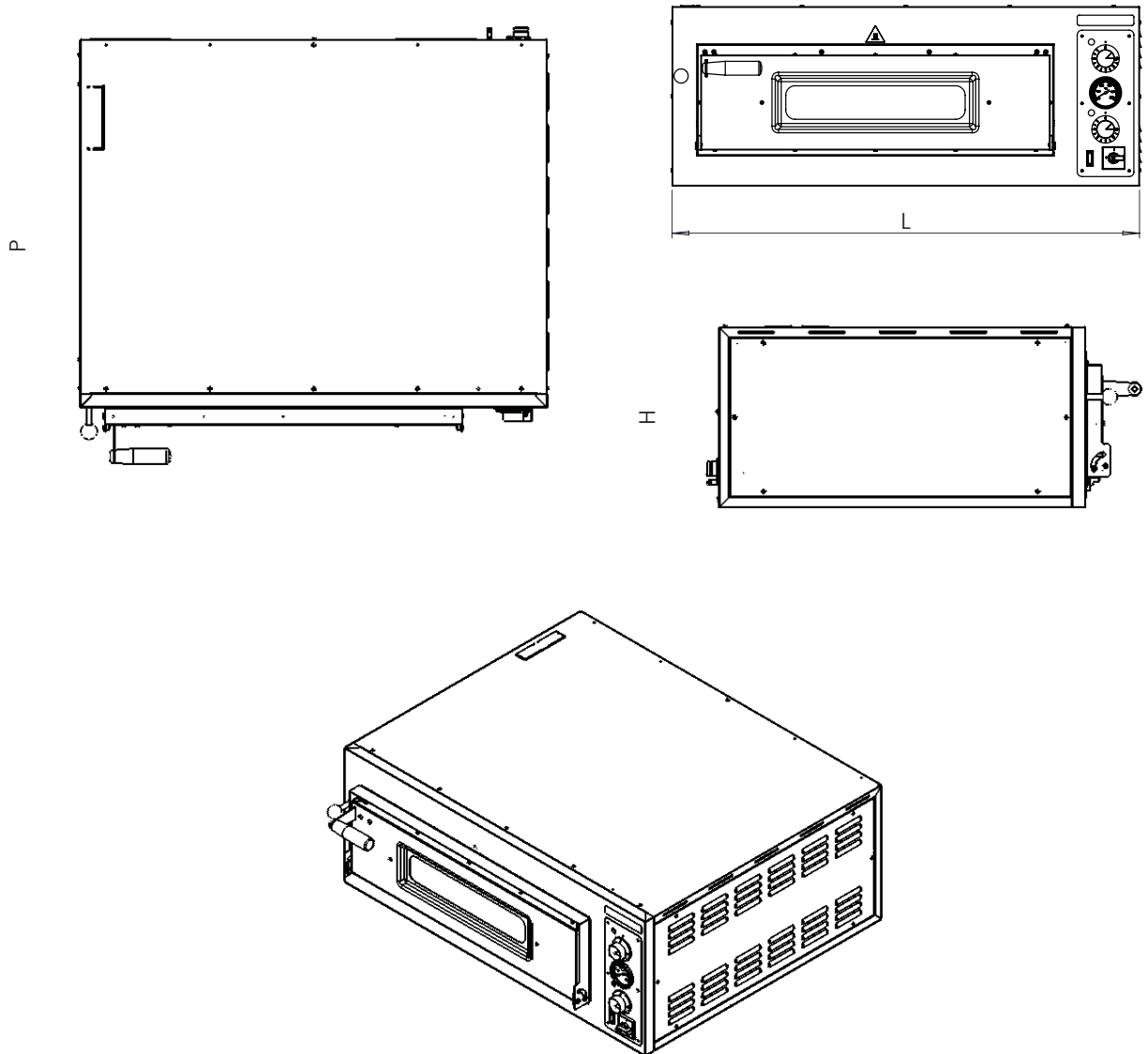

MAX 8



MOD	COD	DIMENSIONS (cm)		
		L	P	H
4	P07EN10083	99	92	38
6	P07EN10084	99	127	38
6L	P07EN10085	134	92	38
9	P07EN10086	134	127	38
8	P07EN10087	99	92	68
12	P07EN10088	99	127	68
12L	P07EN10089	134	92	68
18	P07EN10090	134	127	68



Entry Max

Codice	Modello	Dimensioni LxPxH cm			
P07EN10088	MAX 12	↔ 99	↗ 127	↕ 68	
	Controllo	Altezza camera cm	Superficie di cottura cm		
	Manual	15	70x105		
	Capacità pizze	Temperatura Max	Peso Kg		
	6 x Ø 30/34 (x2)	 450 °C	 155		
	Potenza Totale KW	Voltaggio V	Fasi Ph	Frequenza Hz	
	14,60	400	3N+T	50/60	



Entry Max

Codice

P07EN10088

Modello

MAX 12

Caratteristiche Generali

Disponibile nella versione completamente con pietra refrattaria.

Tempi di riscaldamento, cottura e consumo totale di energia ridotti.

Raggiunge fino a 450° per tutte le esigenze di cottura.



Entry Max

Codice

P07EN10088

Modello

MAX 12

Options

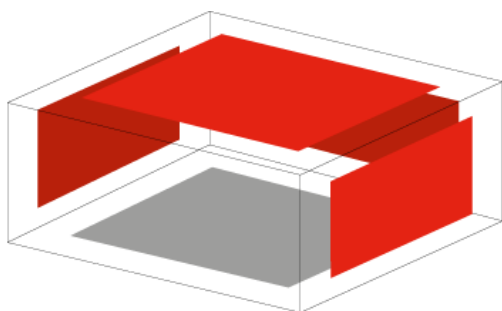

CAMERA REFRATTARIA ENTRY MAX

CAMERA INTERNA RICOPERTA DA PIETRA REFRATTARIA

Dimensioni superficie di cottura (L x p x h cm)

Codice



67x103,5x15

S950065010



Entry Max

Codice
P07EN10088

Modello
MAX 12

Accessori



SUPPORTO ENTRY MAX

SUPPORTO IN ACCIAIO INOX

	Codice	Modello	Dimensioni con piedi cm	Dimensioni con ruote cm	Dimensioni interne cm	Peso
	P11FN55006	S12	99x112x85/88	S12 99x112x86	82x95x53	30

Option

ruote

Set di 4 ruote rotanti 2 con freno + 2 senza freno

Codice

S66RU65003



Entry Max

Codice
P07EN10088

Modello
MAX 12

Accessori



CAPPA ENTRY MAX

CAPPA IN ACCIAIO INOX DIAMETRO USCITA FUMI 125-200mm

	Codice	Modello	Voltage V	Fasi Ph	Frequenza Hz	Luce	Dimensioni cm	Peso
	P13EN10011	K6 - K12	230	1N + T	50	S	99x123x15	13

Option

MOTORE CAPPA

MOTORE ELETTRICO DI ASPIRAZIONE (ASSORBIMENTO 50 w) Con regolazione velocità - power 313 m3/h

	Codice	Alimentazione V	Fasi Ph	Frequenza Hz	Peso netto Kg
	S66MT55001	230	1N + T	50	3



Entry Max

Codice

P07EN10088

Modello



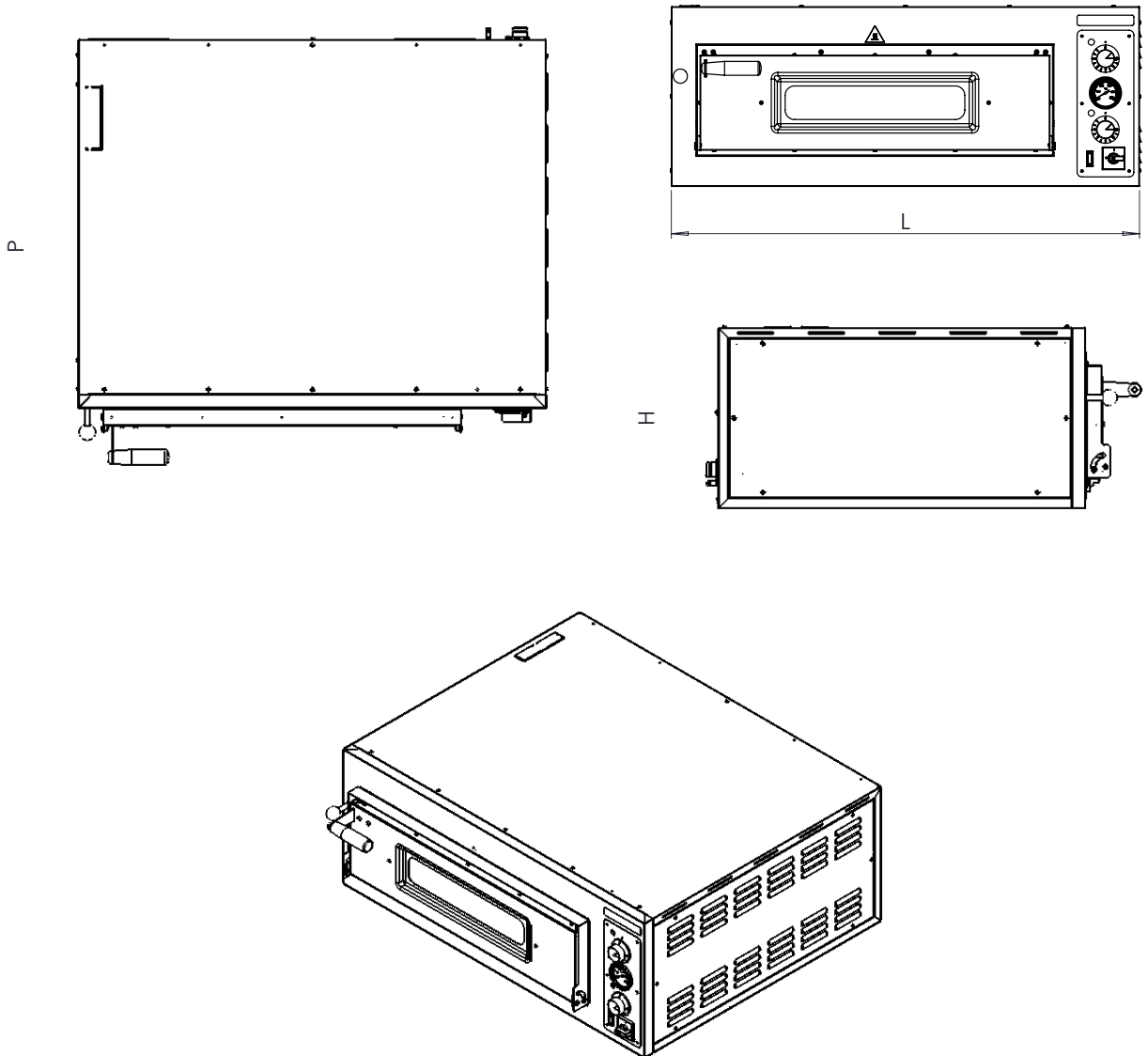

MAX 12



MOD	COD	DIMENSIONS (cm)		
		L	P	H
4	P07EN10083	99	92	38
6	P07EN10084	99	127	38
6L	P07EN10085	134	92	38
9	P07EN10086	134	127	38
8	P07EN10087	99	92	68
12	P07EN10088	99	127	68
12L	P07EN10089	134	92	68
18	P07EN10090	134	127	68



Entry Max

Codice	Modello	Dimensioni LxPxH cm			
P07EN10089	MAX 12L	↔ 134	↗ 92	↕ 68	
	Controllo	Altezza camera cm	Superficie di cottura cm		
	Manual	15	105x70		
	Capacità pizze	Temperatura Max	Peso Kg		
	6 x Ø 30/34 (x2)	 450 °C	 177		
	Potenza Totale KW	Voltaggio V	Fasi Ph	Frequenza Hz	
	19,80	400	3N+T	50/60	



Entry Max

Codice

P07EN10089

Modello

MAX 12L

Caratteristiche Generali

Disponibile nella versione completamente con pietra refrattaria.

Tempi di riscaldamento, cottura e consumo totale di energia ridotti.

Raggiunge fino a 450° per tutte le esigenze di cottura.



Entry Max

Codice

P07EN10089

Modello

MAX 12L

Options

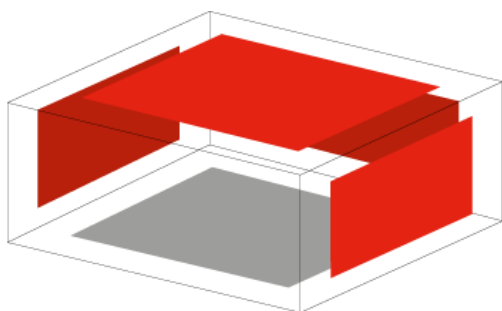

CAMERA REFRAATTARIA ENTRY MAX

CAMERA INTERNA RICOPERTA DA PIETRA REFRAATTARIA

Dimensioni superficie di cottura (L x p x h cm)

Codice



102x68,5x15

S950065011



Entry Max

Codice
P07EN10089

Modello
MAX 12L

Accessori



SUPPORTO ENTRY MAX

SUPPORTO IN ACCIAIO INOX

	Codice	Modello	Dimensioni con piedi cm	Dimensioni con ruote cm	Dimensioni interne cm	Peso
	P11FN55007	S12L	132x82x85/88	S12L 132x82x86	115x65x53	30

Option

ruote

Set di 4 ruote rotanti 2 con freno + 2 senza freno

Codice

S66RU65003



Entry Max

Codice

P07EN10089

Modello



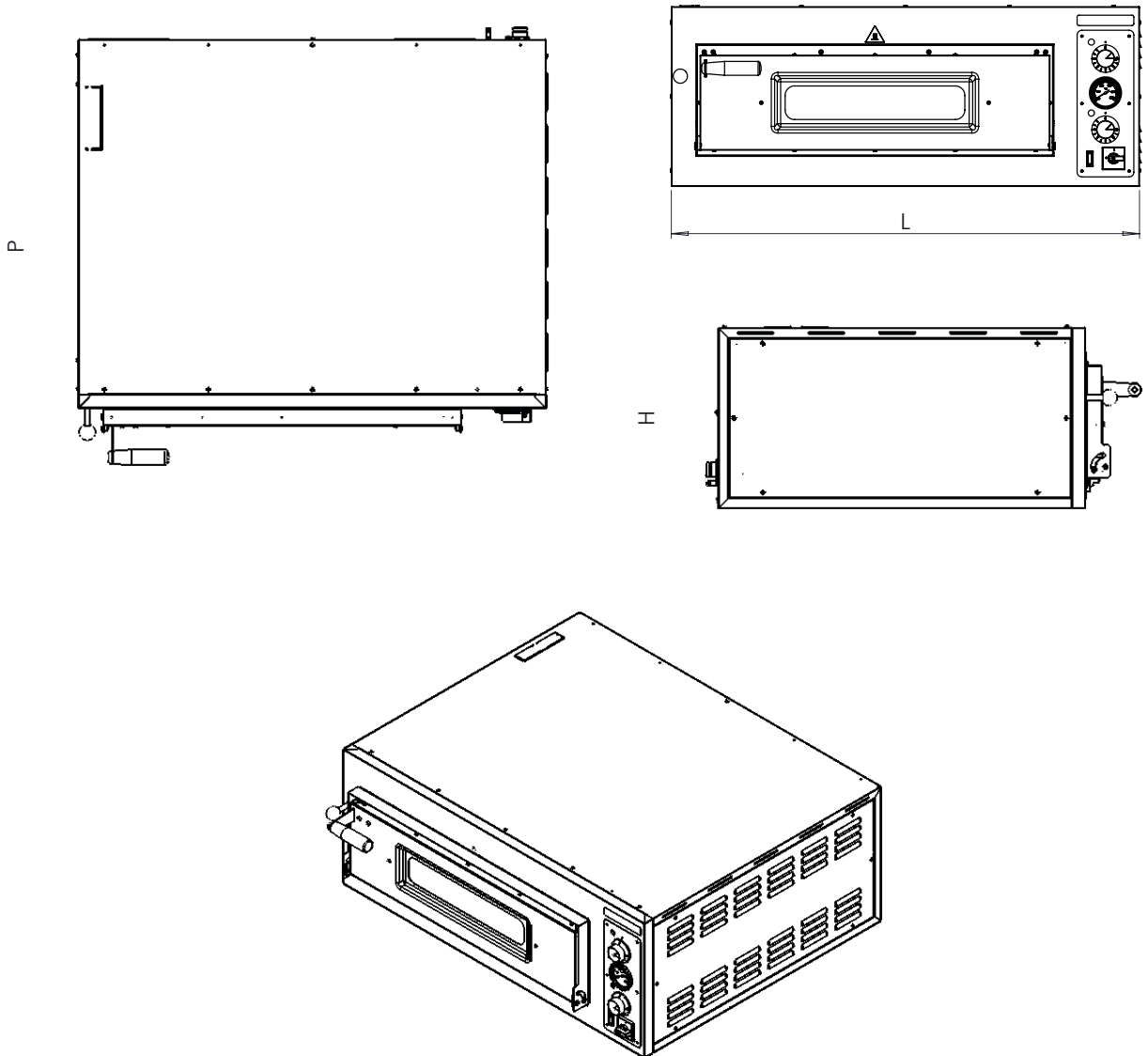

MAX 12L



MOD	COD	DIMENSIONS (cm)		
		L	P	H
4	P07EN10083	99	92	38
6	P07EN10084	99	127	38
6L	P07EN10085	134	92	38
9	P07EN10086	134	127	38
8	P07EN10087	99	92	68
12	P07EN10088	99	127	68
12L	P07EN10089	134	92	68
18	P07EN10090	134	127	68



Entry Max

Codice	Modello	Dimensioni LxPxH cm			
P07EN10090	MAX 18	↔ 134	↗ 127	↕ 68	
	Controllo	Altezza camera cm	Superficie di cottura cm		
	Manual	15	105x105		
	Capacità pizze	Temperatura Max	Peso Kg		
	9 x Ø 30/34 (x2)	 450 °C	 235		
	Potenza Totale KW	Voltaggio V	Fasi Ph	Frequenza Hz	
	25,80	400	3N+T	50/60	



Entry Max

Codice

P07EN10090

Modello

MAX 18

Caratteristiche Generali

Disponibile nella versione completamente con pietra refrattaria.

Tempi di riscaldamento, cottura e consumo totale di energia ridotti.

Raggiunge fino a 450° per tutte le esigenze di cottura.



Entry Max

Codice

P07EN10090

Modello

MAX 18

Options

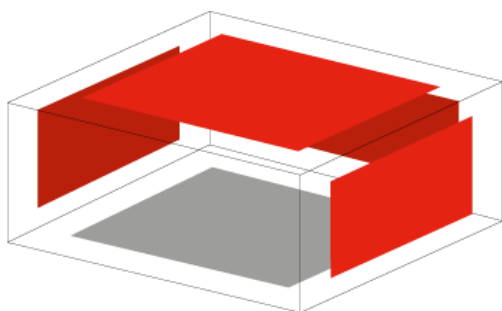

CAMERA REFRAATTARIA ENTRY MAX

CAMERA INTERNA RICOPERTA DA PIETRA REFRAATTARIA

Dimensioni superficie di cottura (L x p x h cm)

Codice



102x103,5x15

S950065012



Entry Max

Codice
P07EN10090

Modello
MAX 18

Accessori



SUPPORTO ENTRY MAX

SUPPORTO IN ACCIAIO INOX

	Codice	Modello	Dimensioni con piedi cm	Dimensioni con ruote cm	Dimensioni interne cm	Peso
	P11FN55008	S18	132x112x85/88	S18 132x112x86	115x95x53	38

Option

ruote

Set di 4 ruote rotanti 2 con freno + 2 senza freno

Codice

S66RU65003



Entry Max

Codice
P07EN10090

Modello
MAX 18

Accessori



CAPPA ENTRY MAX

CAPPA IN ACCIAIO INOX DIAMETRO USCITA FUMI 125-200mm

	Codice	Modello	Voltage V	Fasi Ph	Frequenza Hz	Luce	Dimensioni cm	Peso
	P13EN10013	K9 - K18	230	1N + T	50	S	134x123x15	16

Option

MOTORE CAPPA

MOTORE ELETTRICO DI ASPIRAZIONE (ASSORBIMENTO 50 w) Con regolazione velocità - power 313 m3/h

	Codice	Alimentazione V	Fasi Ph	Frequenza Hz	Peso netto Kg
	S66MT55001	230	1N + T	50	3



Entry Max

Codice

P07EN10090

Modello

MAX 18

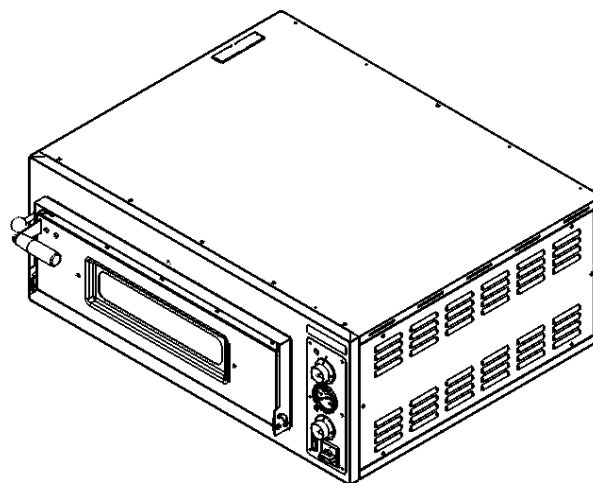
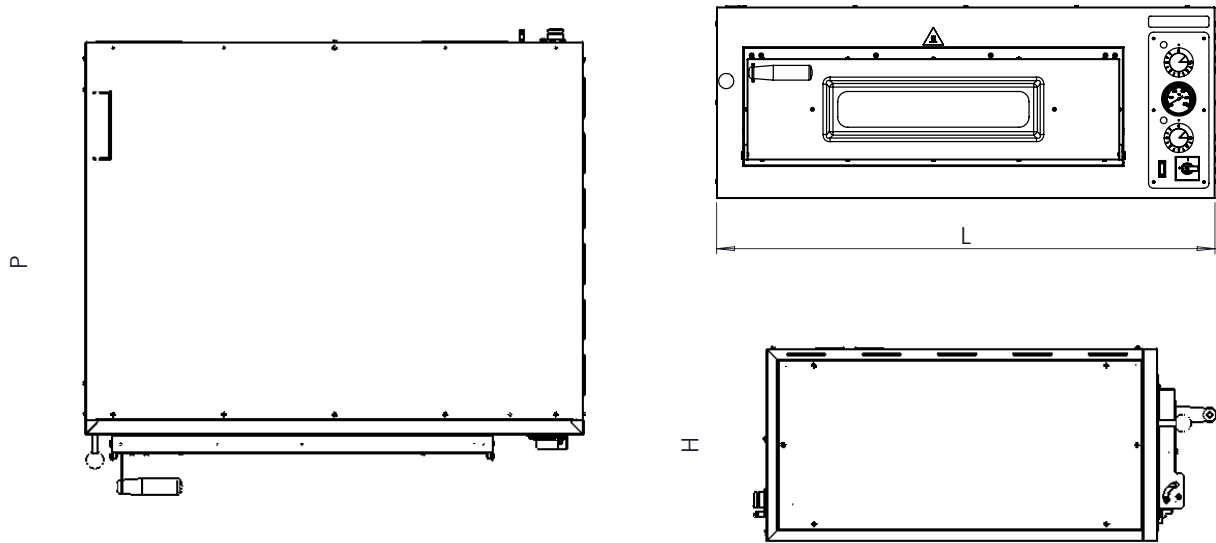

MOD	COD	DIMENSIONS (cm)		
		L	P	H
4	P07EN10083	99	92	38
6	P07EN10084	99	127	38
6L	P07EN10085	134	92	38
9	P07EN10086	134	127	38
8	P07EN10087	99	92	68
12	P07EN10088	99	127	68
12L	P07EN10089	134	92	68
18	P07EN10090	134	127	68

