





Entry Max

Code	Model	Dimensions LxWxH cm			
P07EN10083	MAX 4	↔ 99	↗ 92	↕ 38	
	Control	Chamber height cm	Cooking surface cm		
	Manual	15	70x70		
	Pizza Capacity	Max Temperature	Weight Kg		
	4 x Ø 30/34	 450 °C		74	
	Total Power KW	Voltage V	Phases Ph	Frequency Hz	
	5,60	400	3N+T	50/60	



Entry Max

Code

P07EN10083

Model

MAX 4

General Features

Available in the version with a completely refractory stone.

Reduced heating, cooking times, and total energy consumption.

Reaches up to 450°C for all baking needs.



Entry Max

Code
P07EN10083

Model
MAX 4

Options

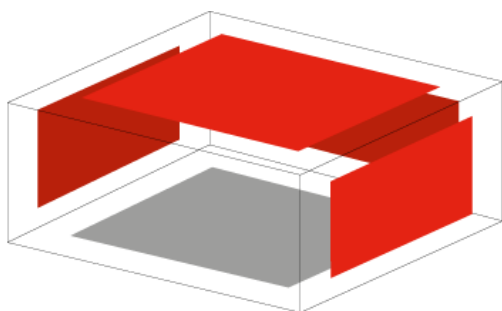

ENTRY MAX REFRACTORY CHAMBER
INTERNAL CHAMBER COVERED WITH REFRACTORY STONE

Cooking surface dimensions (L x W x H cm)

Code



67x68,5x15

S950065001



Entry Max

Code
P07EN10083

Model
MAX 4

Accessories



SUPPORT ENTRY MAX

SUPPORT IN STAINLESS STEEL

	Code	Model	Size with feet cm	Size with wheels cm	Internal dimensions	Peso
	P11FN55001	S4	99x82x105/108	99x82x106	82x65x73	30

Option

wheels

Set of 4 rotating wheels 2 with brake + 2 without brake

Code

S66RU65003



Entry Max

Code
P07EN10083

Model
MAX 4

Accessories



ENTRY MAX HOOD

STAINLESS STEEL HOOD SMOKE OUTLET DIAMETER 125-200mm



Code	Model	Voltage V	Phases Ph	Frequency Hz	Light	Dimensions cm	Peso
P13EN10010	K4-K8	230	1N + T	50	S	99x88x15	10

Option

EXTRACTOR HOOD MOTOR

ELECTRIC SUCTION MOTOR (POWER CONSUMPTION 50 W) With speed adjustment - power 313 m3/h



Code	Power Supply V	Phases Ph	Frequency Hz	Net weight Kg
S66MT55001	230	1N + T	50	3



Entry Max

Code

P07EN10083

Model



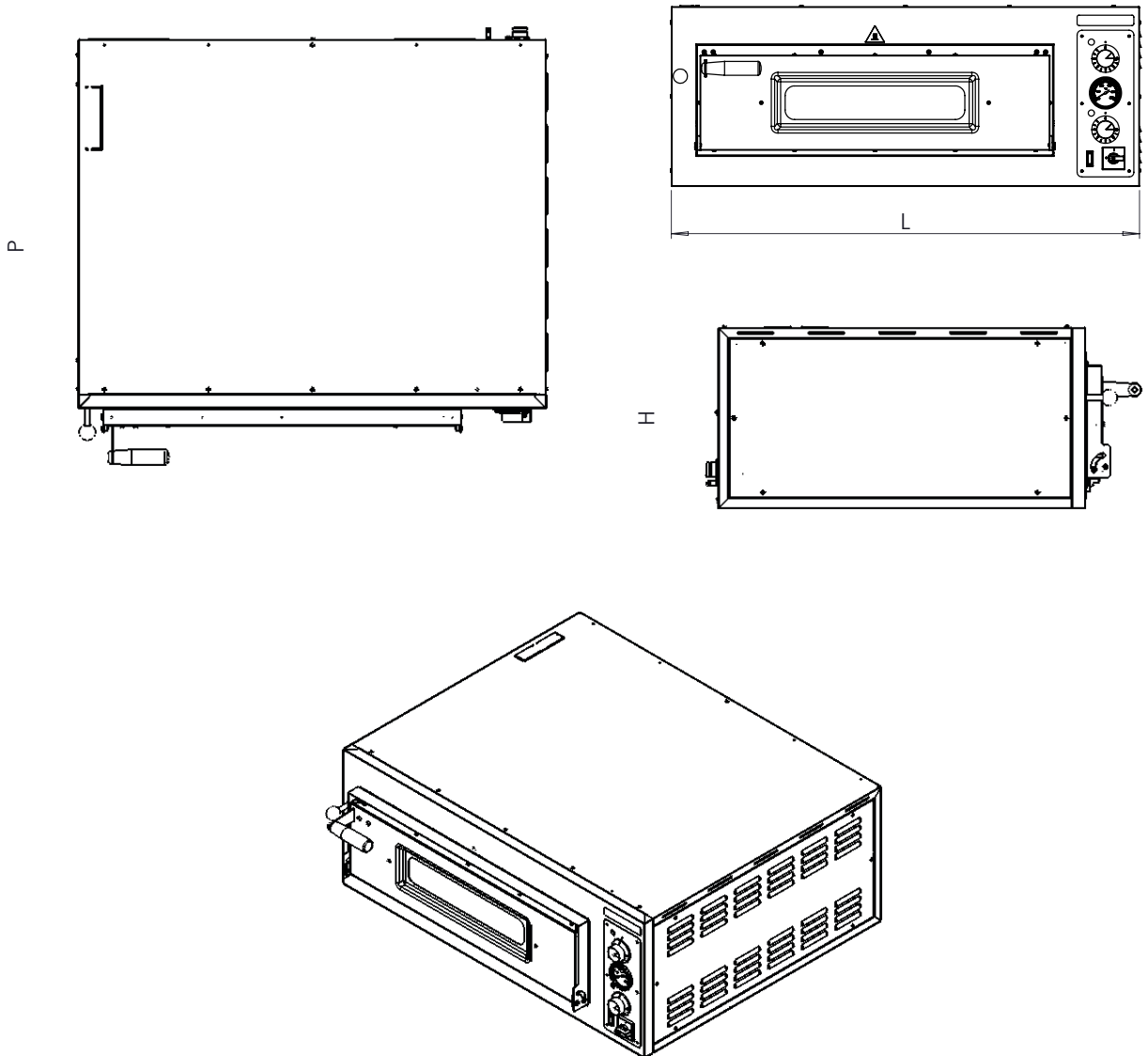

MAX 4



MOD	COD	DIMENSIONS (cm)		
		L	P	H
4	P07EN10083	99	92	38
6	P07EN10084	99	127	38
6L	P07EN10085	134	92	38
9	P07EN10086	134	127	38
8	P07EN10087	99	92	68
12	P07EN10088	99	127	68
12L	P07EN10089	134	92	68
18	P07EN10090	134	127	68



Entry Max

Code	Model	Dimensions LxWxH cm			
P07EN10084	MAX 6	↔ 99	↗ 127	↕ 38	
	Control	Chamber height cm	Cooking surface cm		
	Manual	15	70x105		
	Pizza Capacity	Max Temperature	Weight Kg		
	6 x Ø 30/34	 450 °C	 97		
	Total Power KW	Voltage V	Phases Ph	Frequency Hz	
	7,30	400	3N+T	50/60	



Entry Max

Code

P07EN10084

Model

MAX 6

General Features

Available in the version with a completely refractory stone.

Reduced heating, cooking times, and total energy consumption.

Reaches up to 450°C for all baking needs.



Entry Max

Code
P07EN10084

Model
MAX 6

Options

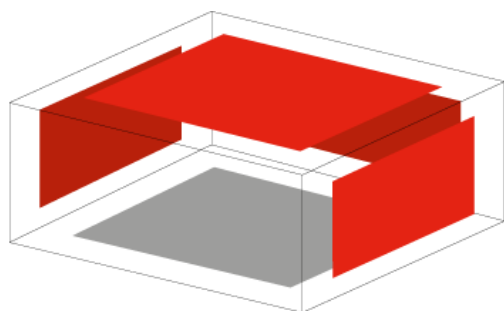

ENTRY MAX REFRACTORY CHAMBER
INTERNAL CHAMBER COVERED WITH REFRACTORY STONE

Cooking surface dimensions (L x W x H cm)

Code



67x103,5x15

S950065002



Entry Max

Code
P07EN10084

Model
MAX 6

Accessories



SUPPORT ENTRY MAX

SUPPORT IN STAINLESS STEEL

	Code	Model	Size with feet cm	Size with wheels cm	Internal dimensions	Peso
	P11FN55002	S6	99x112x105/108	S6 99x112x106	82x95x73	31

Option

wheels

Set of 4 rotating wheels 2 with brake + 2 without brake

Code

S66RU65003



Entry Max

Code
P07EN10084

Model
MAX 6

Accessories



ENTRY MAX HOOD

STAINLESS STEEL HOOD SMOKE OUTLET DIAMETER 125-200mm



Code	Model	Voltage V	Phases Ph	Frequency Hz	Light	Dimensions cm	Peso
P13EN10011	K6 - K12	230	1N + T	50	S	99x123x15	13

Option

EXTRACTOR HOOD MOTOR

ELECTRIC SUCTION MOTOR (POWER CONSUMPTION 50 W) With speed adjustment - power 313 m³/h



Code	Power Supply V	Phases Ph	Frequency Hz	Net weight Kg
S66MT55001	230	1N + T	50	3



Entry Max

Code

P07EN10084

Model



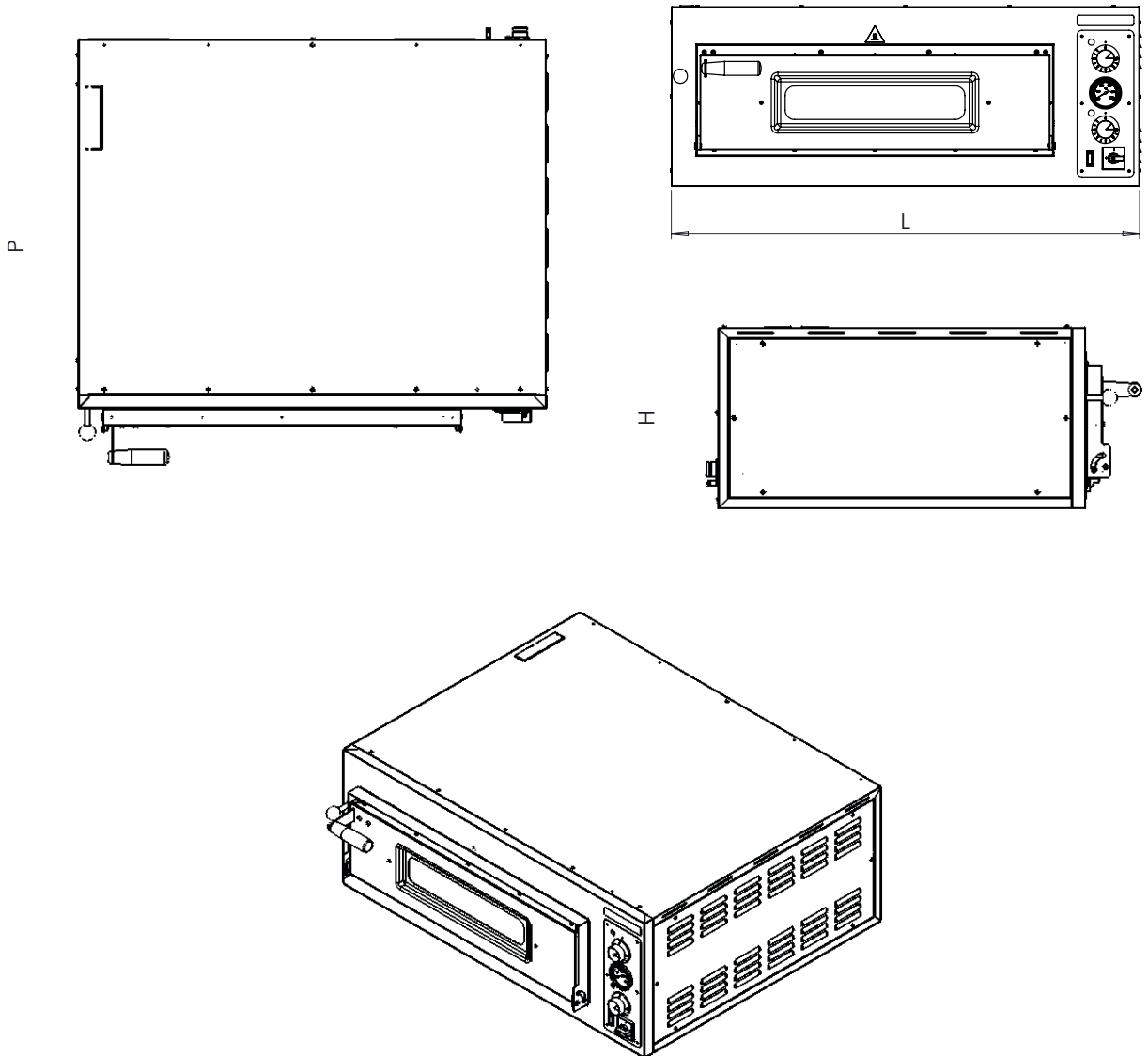

MAX 6



MOD	COD	DIMENSIONS (cm)		
		L	P	H
4	P07EN10083	99	92	38
6	P07EN10084	99	127	38
6L	P07EN10085	134	92	38
9	P07EN10086	134	127	38
8	P07EN10087	99	92	68
12	P07EN10088	99	127	68
12L	P07EN10089	134	92	68
18	P07EN10090	134	127	68



Entry Max

Code	Model	Dimensions LxWxH cm			
P07EN10085	MAX 6L	↔ 134	↗ 92	↕ 38	
	Control	Chamber height cm	Cooking surface cm		
	Manual	15	105x70		
	Pizza Capacity	Max Temperature	Weight Kg		
	6 x Ø 30/34	 450 °C	 97		
	Total Power KW	Voltage V	Phases Ph	Frequency Hz	
	9,90	400	3N+T	50/60	



Entry Max

Code

P07EN10085

Model

MAX 6L

General Features

Available in the version with a completely refractory stone.

Reduced heating, cooking times, and total energy consumption.

Reaches up to 450°C for all baking needs.



Entry Max

Code
P07EN10085

Model
MAX 6L

Options

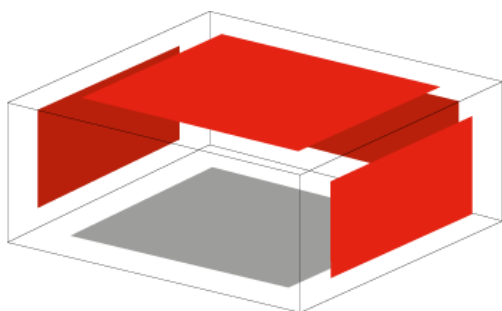

ENTRY MAX REFRACTORY CHAMBER
INTERNAL CHAMBER COVERED WITH REFRACTORY STONE

Cooking surface dimensions (L x W x H cm)

Code



102x68,5x15

S950065003



Entry Max

Code
P07EN10085

Model
MAX 6L

Accessories



SUPPORT ENTRY MAX

SUPPORT IN STAINLESS STEEL

	Code	Model	Size with feet cm	Size with wheels cm	Internal dimensions	Peso
	P11FN55003	S6L	132x82x105/108	S6L 132x82x106	115x65x73	31

Option

wheels

Set of 4 rotating wheels 2 with brake + 2 without brake

Code

S66RU65003



Entry Max

Code
P07EN10085

Model
MAX 6L

Accessories



ENTRY MAX HOOD

STAINLESS STEEL HOOD SMOKE OUTLET DIAMETER 125-200mm



Code	Model	Voltage V	Phases Ph	Frequency Hz	Light	Dimensions cm	Peso
P13EN10012	K6L - K12L	230	1N + T	50	S	134x88x15	13

Option

EXTRACTOR HOOD MOTOR

ELECTRIC SUCTION MOTOR (POWER CONSUMPTION 50 W) With speed adjustment - power 313 m³/h



Code	Power Supply V	Phases Ph	Frequency Hz	Net weight Kg
S66MT55001	230	1N + T	50	3



Entry Max

Code

P07EN10085

Model

MAX 6L

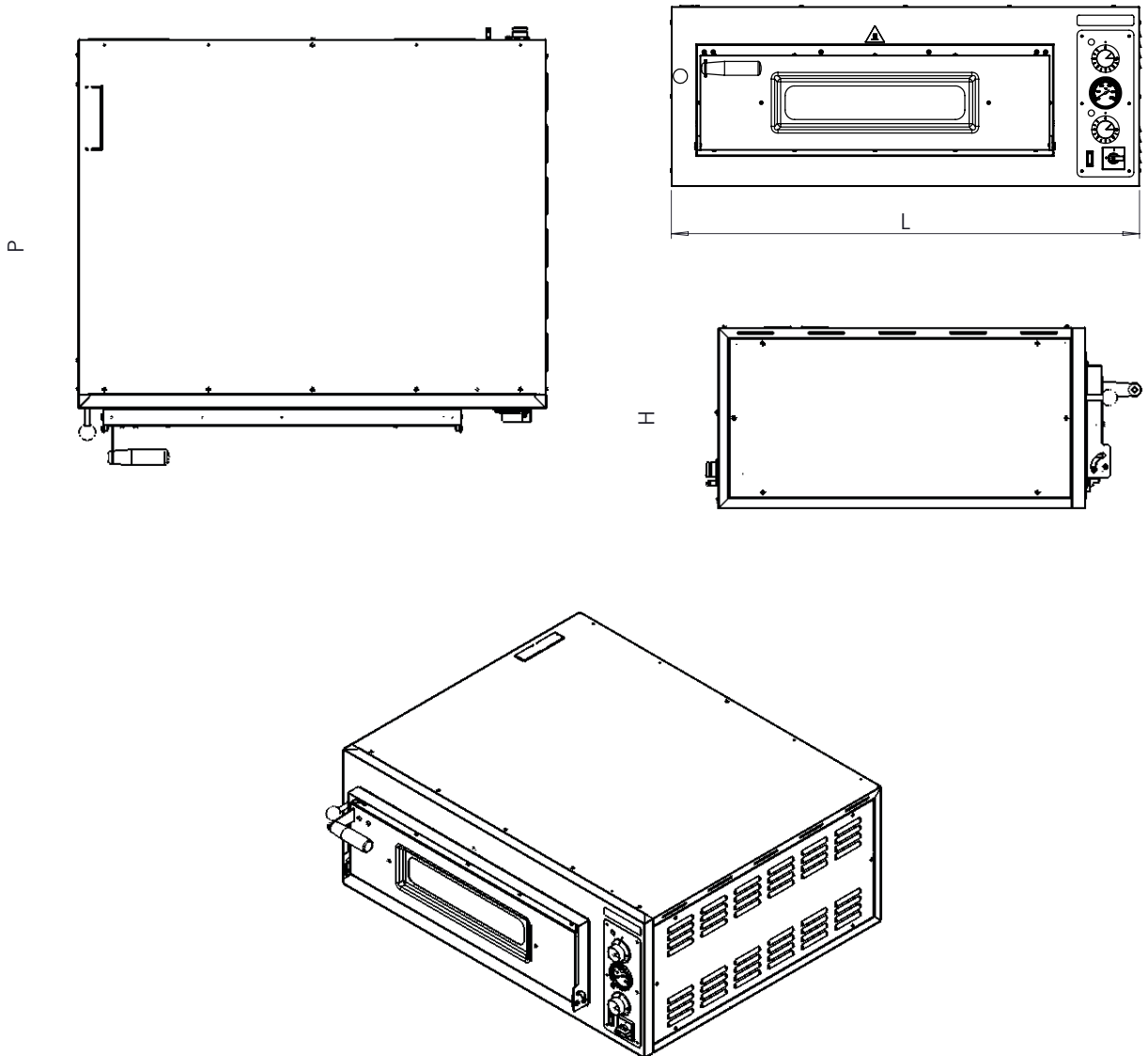

MOD





COD

DIMENSIONS (cm)

		L	P	H
4	P07EN10083	99	92	38
6	P07EN10084	99	127	38
6L	P07EN10085	134	92	38
9	P07EN10086	134	127	38
8	P07EN10087	99	92	68
12	P07EN10088	99	127	68
12L	P07EN10089	134	92	68
18	P07EN10090	134	127	68



Entry Max

Code	Model	Dimensions LxWxH cm			
P07EN10086	MAX 9	↔ 134	↗ 127	↕ 38	
	Control	Chamber height cm	Cooking surface cm		
	Manual	15	105x105		
	Pizza Capacity	Max Temperature	Weight Kg		
	9 x Ø 30/34	 450 °C	 130		
	Total Power KW	Voltage V	Phases Ph	Frequency Hz	
	12,90	400	3N+T	50/60	



Entry Max

Code

P07EN10086

Model

MAX 9

General Features

Available in the version with a completely refractory stone.

Reduced heating, cooking times, and total energy consumption.

Reaches up to 450°C for all baking needs.



Entry Max

Code

P07EN10086

Model

MAX 9

Options

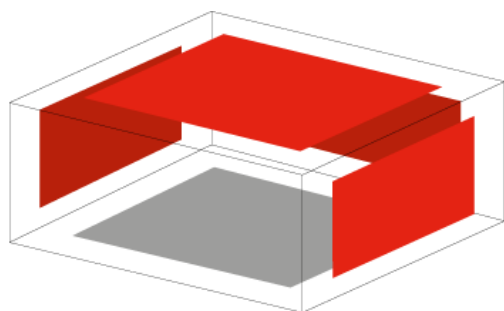

ENTRY MAX REFRACTORY CHAMBER

INTERNAL CHAMBER COVERED WITH REFRACTORY STONE

Cooking surface dimensions (L x W x H cm)

Code



102x103,5x15

S950065004



Entry Max

Code
P07EN10086

Model
MAX 9

Accessories



SUPPORT ENTRY MAX

SUPPORT IN STAINLESS STEEL

	Code	Model	Size with feet cm	Size with wheels cm	Internal dimensions	Peso
	P11FN55004	S9	132x112x105/108	S9 132x112x106	115x95x73	33

Option

wheels

Set of 4 rotating wheels 2 with brake + 2 without brake

Code

S66RU65003



Entry Max

Code
P07EN10086

Model
MAX 9

Accessories



ENTRY MAX HOOD

STAINLESS STEEL HOOD SMOKE OUTLET DIAMETER 125-200mm



Code	Model	Voltage V	Phases Ph	Frequency Hz	Light	Dimensions cm	Peso
P13EN10013	K9 - K18	230	1N + T	50	S	134x123x15	16

Option

EXTRACTOR HOOD MOTOR

ELECTRIC SUCTION MOTOR (POWER CONSUMPTION 50 W) With speed adjustment - power 313 m3/h



Code	Power Supply V	Phases Ph	Frequency Hz	Net weight Kg
S66MT55001	230	1N + T	50	3



Entry Max

Code

P07EN10086

Model



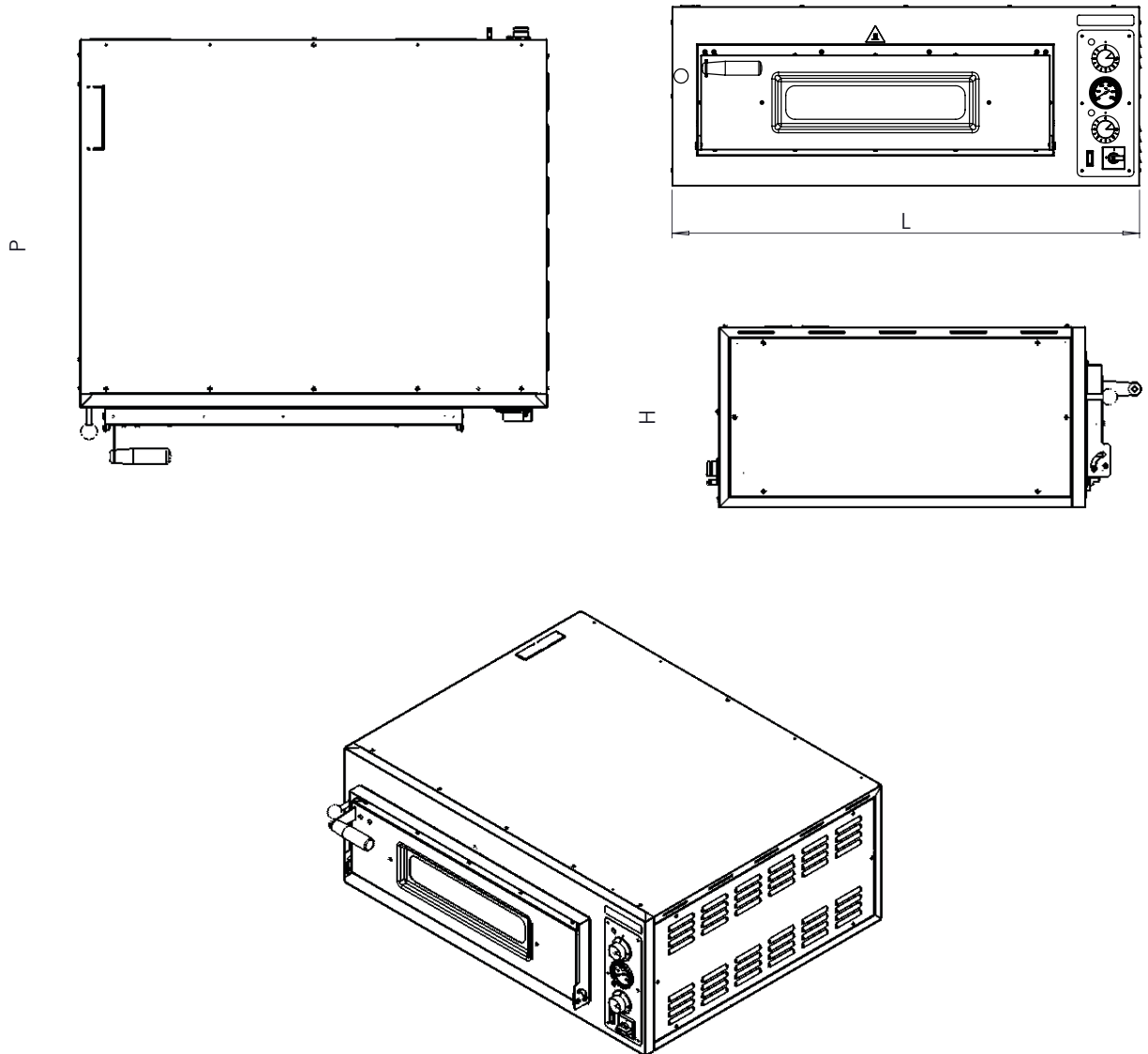

MAX 9



MOD	COD	DIMENSIONS (cm)		
		L	P	H
4	P07EN10083	99	92	38
6	P07EN10084	99	127	38
6L	P07EN10085	134	92	38
9	P07EN10086	134	127	38
8	P07EN10087	99	92	68
12	P07EN10088	99	127	68
12L	P07EN10089	134	92	68
18	P07EN10090	134	127	68



Entry Max

Code	Model	Dimensions LxWxH cm			
P07EN10087	MAX 8	↔ 99	↗ 92	↕ 68	
	Control	Chamber height cm	Cooking surface cm		
	Manual	15	70x70		
	Pizza Capacity	Max Temperature	Weight Kg		
	4 x Ø 30/34 (x2)	 450 °C	 149		
	Total Power KW	Voltage V	Phases Ph	Frequency Hz	
	11,20	400	3N+T	50/60	



Entry Max

Code

P07EN10087

Model

MAX 8

General Features

Available in the version with a completely refractory stone.

Reduced heating, cooking times, and total energy consumption.

Reaches up to 450°C for all baking needs.



Entry Max

Code
P07EN10087

Model
MAX 8

Options

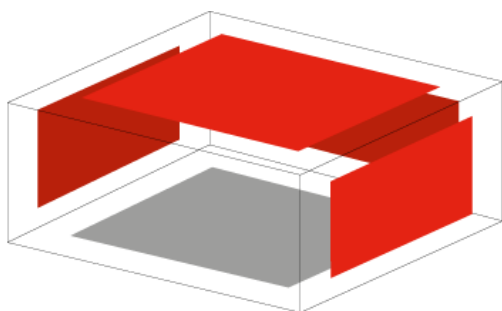

ENTRY MAX REFRACTORY CHAMBER
INTERNAL CHAMBER COVERED WITH REFRACTORY STONE

Cooking surface dimensions (L x W x H cm)

Code



67x68,5x15

S950065009



Entry Max

Code
P07EN10087

Model
MAX 8

Accessories



SUPPORT ENTRY MAX

SUPPORT IN STAINLESS STEEL

	Code	Model	Size with feet cm	Size with wheels cm	Internal dimensions	Peso
	P11FN55005	S8	99x82x85/88	S8 99x82x86	82x65x53	28

Option

wheels

Set of 4 rotating wheels 2 with brake + 2 without brake

Code

S66RU65003



Entry Max

Code
P07EN10087

Model
MAX 8

Accessories



ENTRY MAX HOOD

STAINLESS STEEL HOOD SMOKE OUTLET DIAMETER 125-200mm



Code	Model	Voltage V	Phases Ph	Frequency Hz	Light	Dimensions cm	Peso
P13EN10010	K4-K8	230	1N + T	50	S	99x88x15	10

Option

EXTRACTOR HOOD MOTOR

ELECTRIC SUCTION MOTOR (POWER CONSUMPTION 50 W) With speed adjustment - power 313 m3/h



Code	Power Supply V	Phases Ph	Frequency Hz	Net weight Kg
S66MT55001	230	1N + T	50	3



Entry Max

Code

P07EN10087

Model



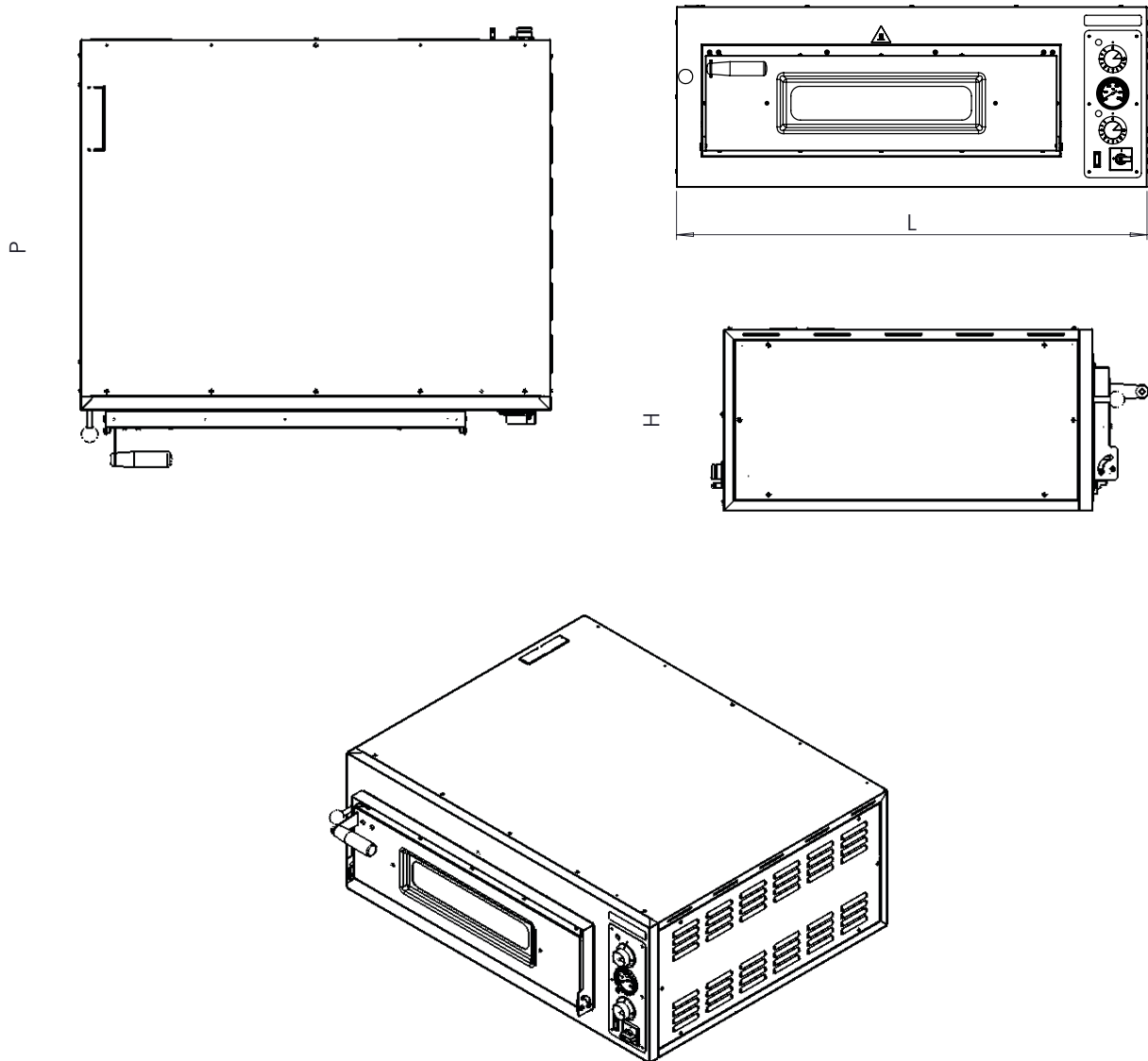

MAX 8



MOD	COD	DIMENSIONS (cm)		
		L	P	H
4	P07EN10083	99	92	38
6	P07EN10084	99	127	38
6L	P07EN10085	134	92	38
9	P07EN10086	134	127	38
8	P07EN10087	99	92	68
12	P07EN10088	99	127	68
12L	P07EN10089	134	92	68
18	P07EN10090	134	127	68



Entry Max

Code	Model	Dimensions LxWxH cm			
P07EN10088	MAX 12	↔ 99	↗ 127	↕ 68	
	Control	Chamber height cm	Cooking surface cm		
	Manual	15	70x105		
	Pizza Capacity	Max Temperature	Weight Kg		
	6 x Ø 30/34 (x2)	 450 °C	 155		
	Total Power KW	Voltage V	Phases Ph	Frequency Hz	
	14,60	400	3N+T	50/60	



Entry Max

Code

P07EN10088

Model

MAX 12

General Features

Available in the version with a completely refractory stone.

Reduced heating, cooking times, and total energy consumption.

Reaches up to 450°C for all baking needs.



Entry Max

Code
P07EN10088

Model
MAX 12

Options

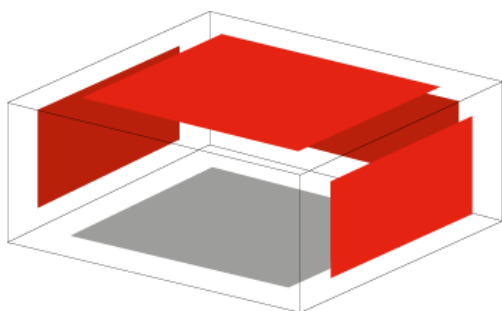

ENTRY MAX REFRACTORY CHAMBER
INTERNAL CHAMBER COVERED WITH REFRACTORY STONE

Cooking surface dimensions (L x W x H cm)

Code



67x103,5x15

S950065010



Entry Max

Code
P07EN10088

Model
MAX 12

Accessories



SUPPORT ENTRY MAX

SUPPORT IN STAINLESS STEEL

	Code	Model	Size with feet cm	Size with wheels cm	Internal dimensions	Peso
	P11FN55006	S12	99x112x85/88	S12 99x112x86	82x95x53	30

Option

wheels

Set of 4 rotating wheels 2 with brake + 2 without brake

Code

S66RU65003



Entry Max

Code
P07EN10088

Model
MAX 12

Accessories



ENTRY MAX HOOD

STAINLESS STEEL HOOD SMOKE OUTLET DIAMETER 125-200mm



Code	Model	Voltage V	Phases Ph	Frequency Hz	Light	Dimensions cm	Peso
P13EN10011	K6 - K12	230	1N + T	50	S	99x123x15	13

Option

EXTRACTOR HOOD MOTOR

ELECTRIC SUCTION MOTOR (POWER CONSUMPTION 50 W) With speed adjustment - power 313 m3/h



Code	Power Supply V	Phases Ph	Frequency Hz	Net weight Kg
S66MT55001	230	1N + T	50	3



Entry Max

Code

P07EN10088

Model

MAX 12

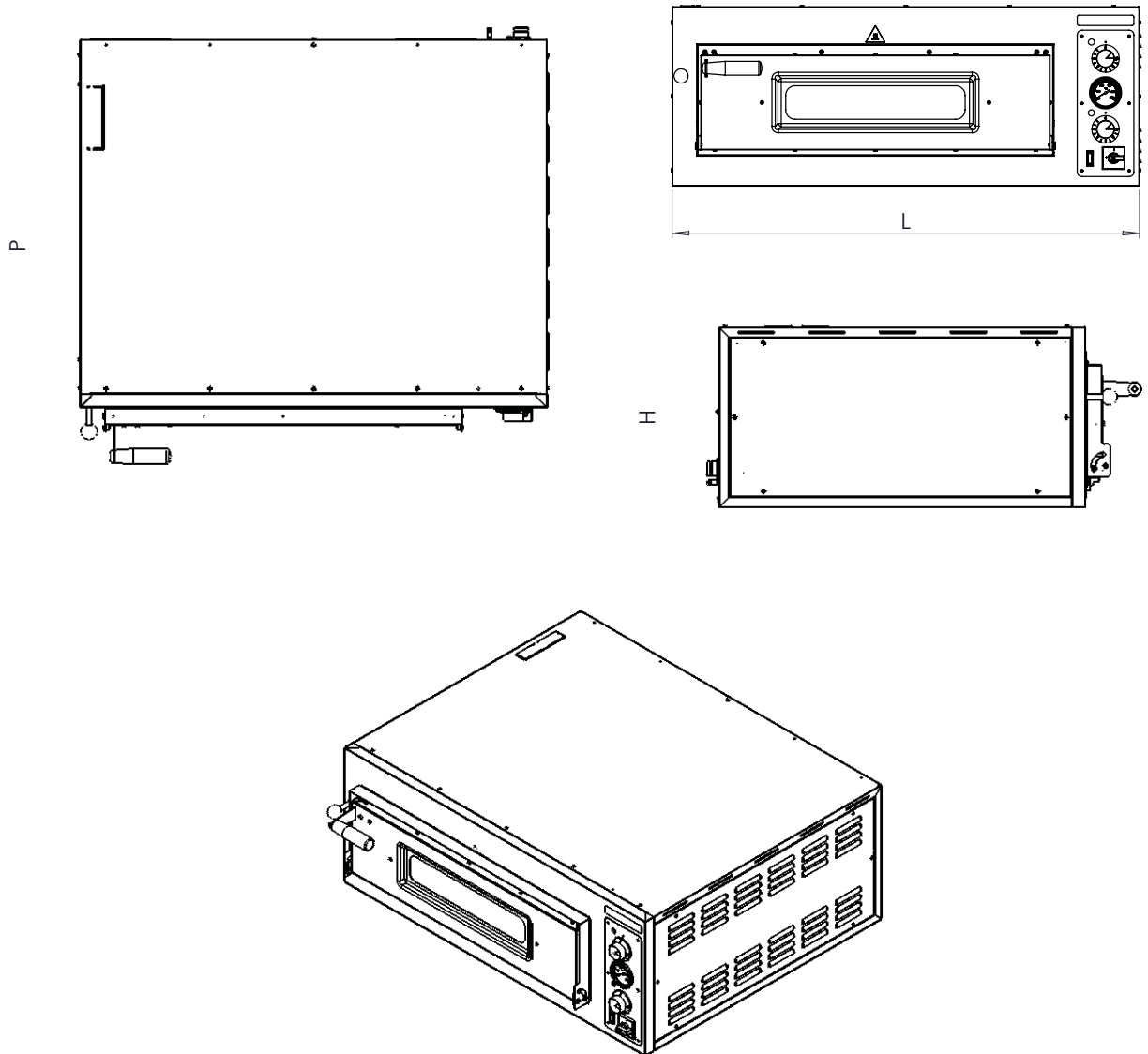

MOD





COD

DIMENSIONS (cm)

		L	P	H
4	P07EN10083	99	92	38
6	P07EN10084	99	127	38
6L	P07EN10085	134	92	38
9	P07EN10086	134	127	38
8	P07EN10087	99	92	68
12	P07EN10088	99	127	68
12L	P07EN10089	134	92	68
18	P07EN10090	134	127	68



Entry Max

Code	Model	Dimensions LxWxH cm			
P07EN10089	MAX 12L	↔ 134	↗ 92	↕ 68	
	Control	Chamber height cm	Cooking surface cm		
	Manual	15	105x70		
	Pizza Capacity	Max Temperature	Weight Kg		
	6 x Ø 30/34 (x2)	 450 °C	 177		
	Total Power KW	Voltage V	Phases Ph	Frequency Hz	
	19,80	400	3N+T	50/60	



Entry Max

Code

P07EN10089

Model

MAX 12L

General Features

Available in the version with a completely refractory stone.

Reduced heating, cooking times, and total energy consumption.

Reaches up to 450°C for all baking needs.



Entry Max

Code
P07EN10089

Model
MAX 12L

Options

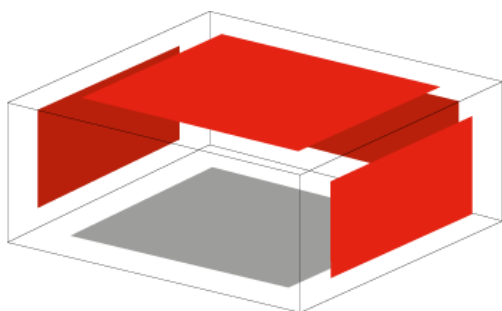

ENTRY MAX REFRACTORY CHAMBER
INTERNAL CHAMBER COVERED WITH REFRACTORY STONE

Cooking surface dimensions (L x W x H cm)

Code



102x68,5x15

S950065011



Entry Max

Code
P07EN10089

Model
MAX 12L

Accessories



SUPPORT ENTRY MAX

SUPPORT IN STAINLESS STEEL

	Code	Model	Size with feet cm	Size with wheels cm	Internal dimensions	Peso
	P11FN55007	S12L	132x82x85/88	S12L 132x82x86	115x65x53	30

Option

wheels

Set of 4 rotating wheels 2 with brake + 2 without brake

Code

S66RU65003



Entry Max

Code

P07EN10089

Model



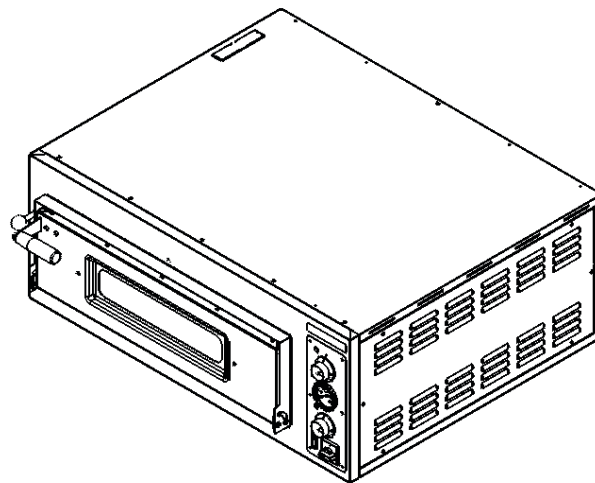
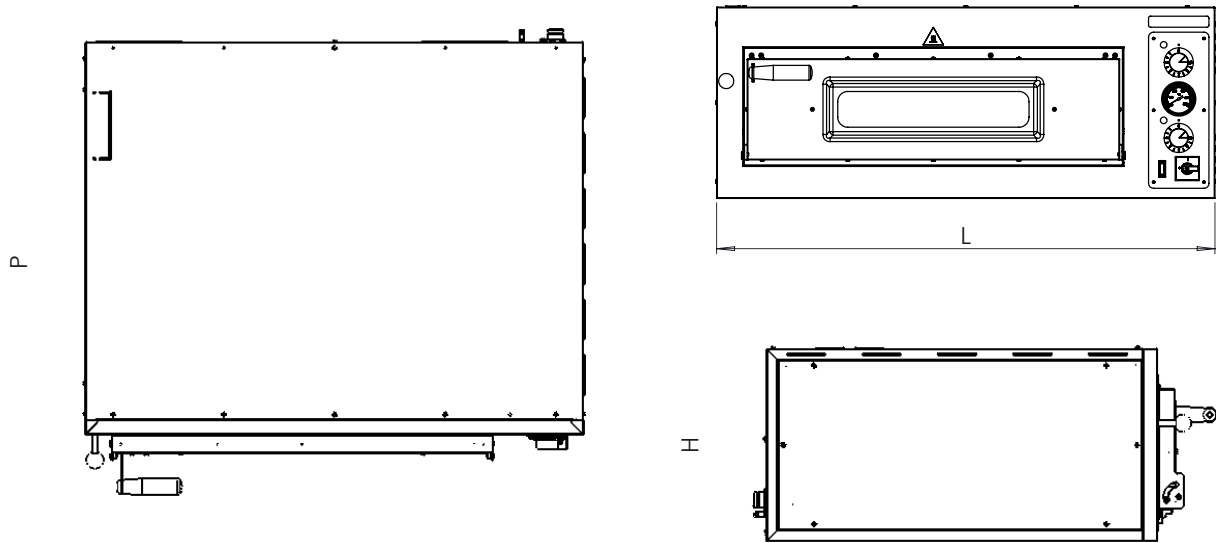

MAX 12L



MOD	COD	DIMENSIONS (cm)		
		L	P	H
4	P07EN10083	99	92	38
6	P07EN10084	99	127	38
6L	P07EN10085	134	92	38
9	P07EN10086	134	127	38
8	P07EN10087	99	92	68
12	P07EN10088	99	127	68
12L	P07EN10089	134	92	68
18	P07EN10090	134	127	68



Entry Max

Code	Model	Dimensions LxWxH cm			
P07EN10090	MAX 18	↔ 134	↗ 127	↕ 68	
	Control	Chamber height cm	Cooking surface cm		
	Manual	15	105x105		
	Pizza Capacity	Max Temperature	Weight Kg		
	9 x Ø 30/34 (x2)	 450 °C	 235		
	Total Power KW	Voltage V	Phases Ph	Frequency Hz	
	25,80	400	3N+T	50/60	



Entry Max

Code

P07EN10090

Model

MAX 18

General Features

Available in the version with a completely refractory stone.

Reduced heating, cooking times, and total energy consumption.

Reaches up to 450°C for all baking needs.



Entry Max

Code

P07EN10090

Model

MAX 18

Options

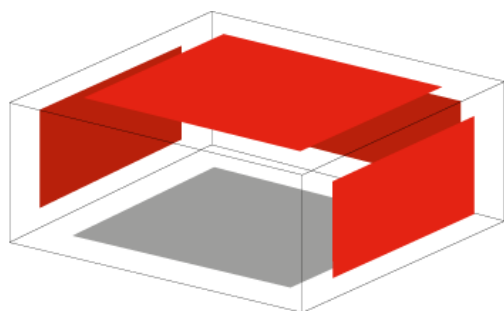

ENTRY MAX REFRACTORY CHAMBER

INTERNAL CHAMBER COVERED WITH REFRACTORY STONE

Cooking surface dimensions (L x W x H cm)

Code



102x103,5x15

S950065012



Entry Max

Code
P07EN10090

Model
MAX 18

Accessories



SUPPORT ENTRY MAX

SUPPORT IN STAINLESS STEEL

	Code	Model	Size with feet cm	Size with wheels cm	Internal dimensions	Peso
	P11FN55008	S18	132x112x85/88	S18 132x112x86	115x95x53	38

Option

wheels

Set of 4 rotating wheels 2 with brake + 2 without brake

Code

S66RU65003



Entry Max

Code
P07EN10090

Model
MAX 18

Accessories



ENTRY MAX HOOD

STAINLESS STEEL HOOD SMOKE OUTLET DIAMETER 125-200mm



Code	Model	Voltage V	Phases Ph	Frequency Hz	Light	Dimensions cm	Peso
P13EN10013	K9 - K18	230	1N + T	50	S	134x123x15	16

Option

EXTRACTOR HOOD MOTOR

ELECTRIC SUCTION MOTOR (POWER CONSUMPTION 50 W) With speed adjustment - power 313 m3/h



Code	Power Supply V	Phases Ph	Frequency Hz	Net weight Kg
S66MT55001	230	1N + T	50	3



Entry Max

Code

P07EN10090

Model

MAX 18

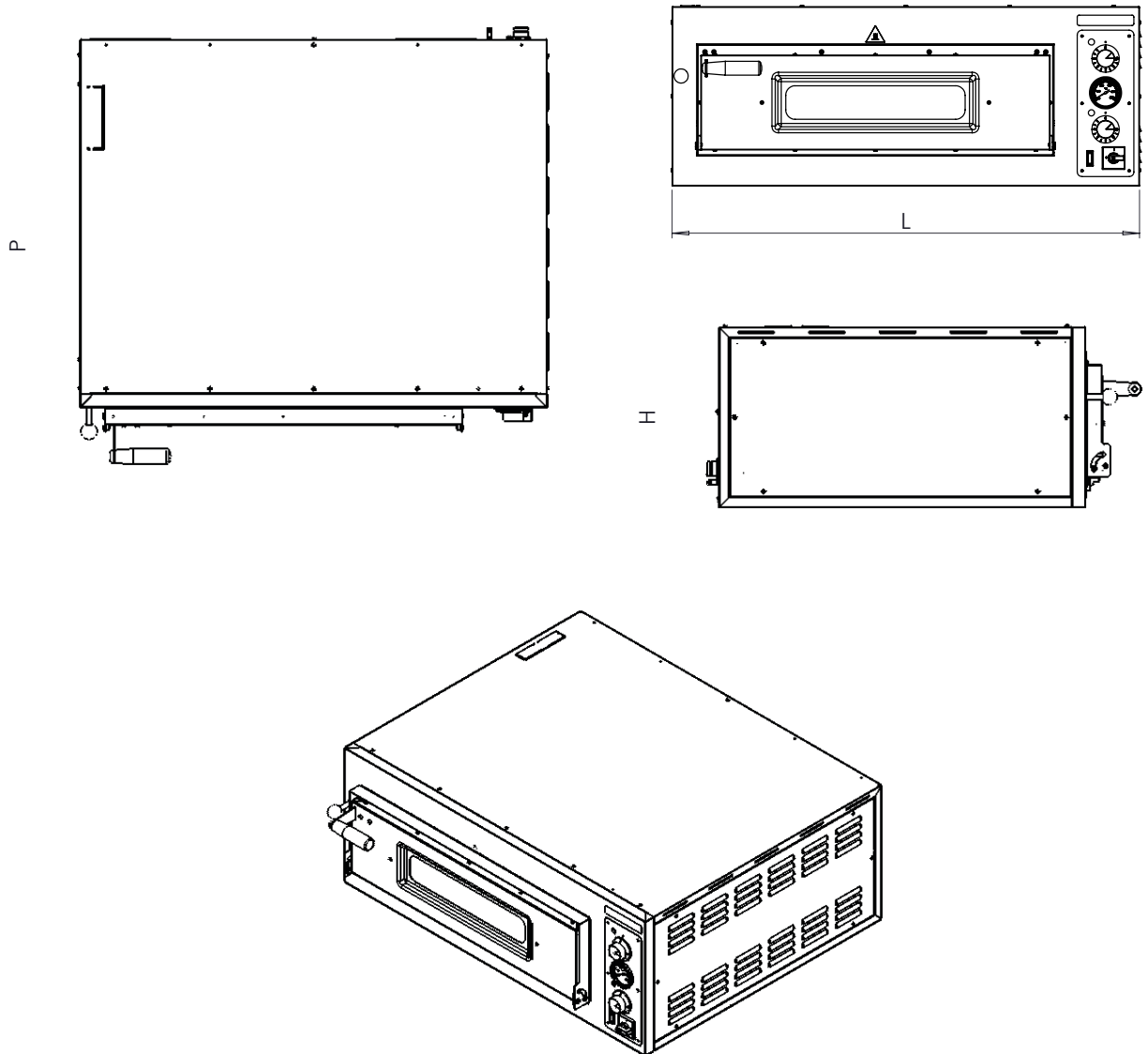

MOD	COD	DIMENSIONS (cm)		
		L	P	H
4	P07EN10083	99	92	38
6	P07EN10084	99	127	38
6L	P07EN10085	134	92	38
9	P07EN10086	134	127	38
8	P07EN10087	99	92	68
12	P07EN10088	99	127	68
12L	P07EN10089	134	92	68
18	P07EN10090	134	127	68

